

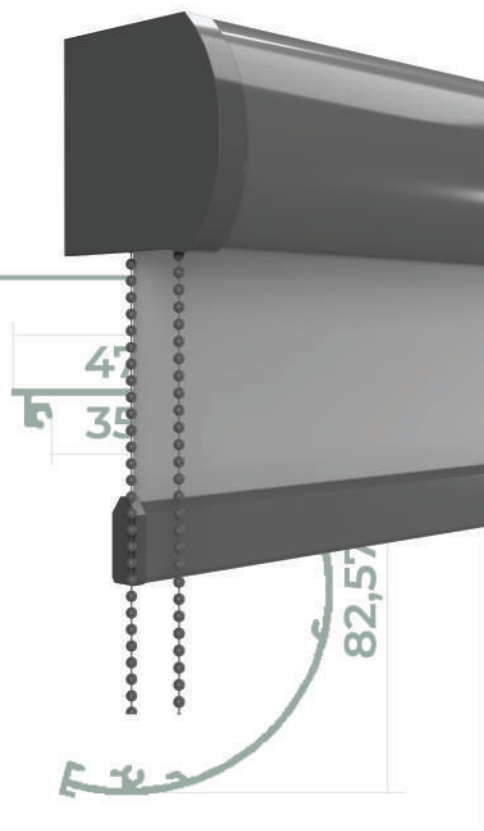

Catálogo de

Personalização

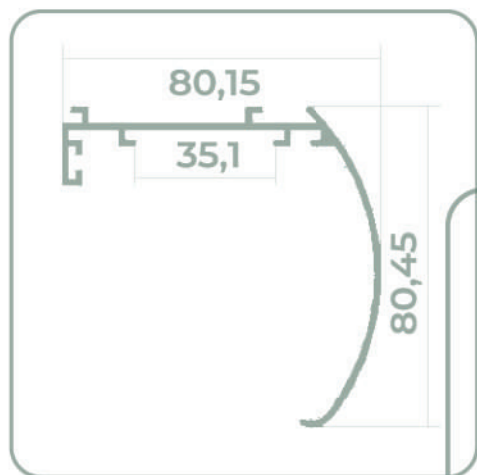

Pensado para quem enxerga valor em cada detalhe.

E quem entende que estética, funcionalidade e identidade formam a base de um espaço verdadeiramente **autêntico**.

Neste material, você encontra o portfólio completo de personalizações da **Persol** — acabamentos, paleta de cores, medidas de vão para instalação e outras especificações técnicas que oferecem liberdade total para compor com precisão.

Mais do que apresentar peças, este catálogo revela as **possibilidades** de personalização que tornam cada projeto **único**.

Um convite para expandir seu repertório e tomar decisões técnicas e criativas com **segurança e exclusividade**.

Inspire-se.



E para acessar **modelos 3D, catálogo digital de materiais** e outros conteúdos, escaneie o **QR Code** ou **clique aqui**.

Perfil Superior

Suporte



Nivelador



Bandô 1720



Bandô New Box



Bandô New Box Premium



Box Redondo 70



Box Redondo 90



Bandô Prime 80



LANÇAMENTO

Bandô Prime 100



LANÇAMENTO

Box Quadrado 90

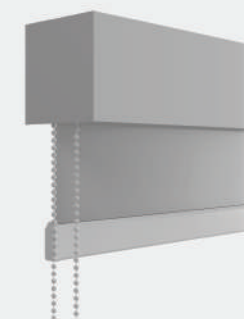

Box Quadrado 100



Box 120 Ultra

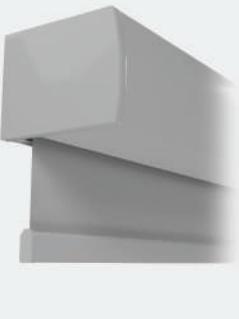

Semi Box 120 Ultra



Bandô Maxi

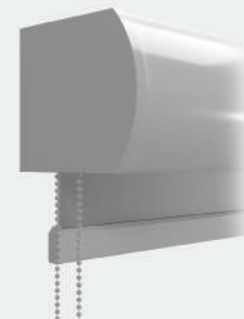

Acionamento Mola



Suporte Duplo Dia e Noite

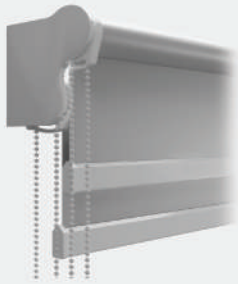

Trilho Deslizante



Guia Lateral

Guia Lateral 60mm



Guia Lateral 80mm

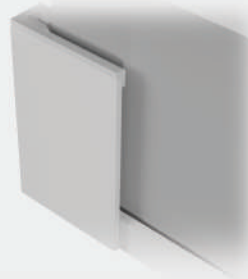

Base

Base Slim



Base Revestida com Solda



Base Oval Revestida

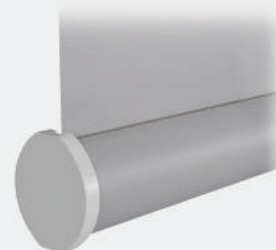



SUPORTE

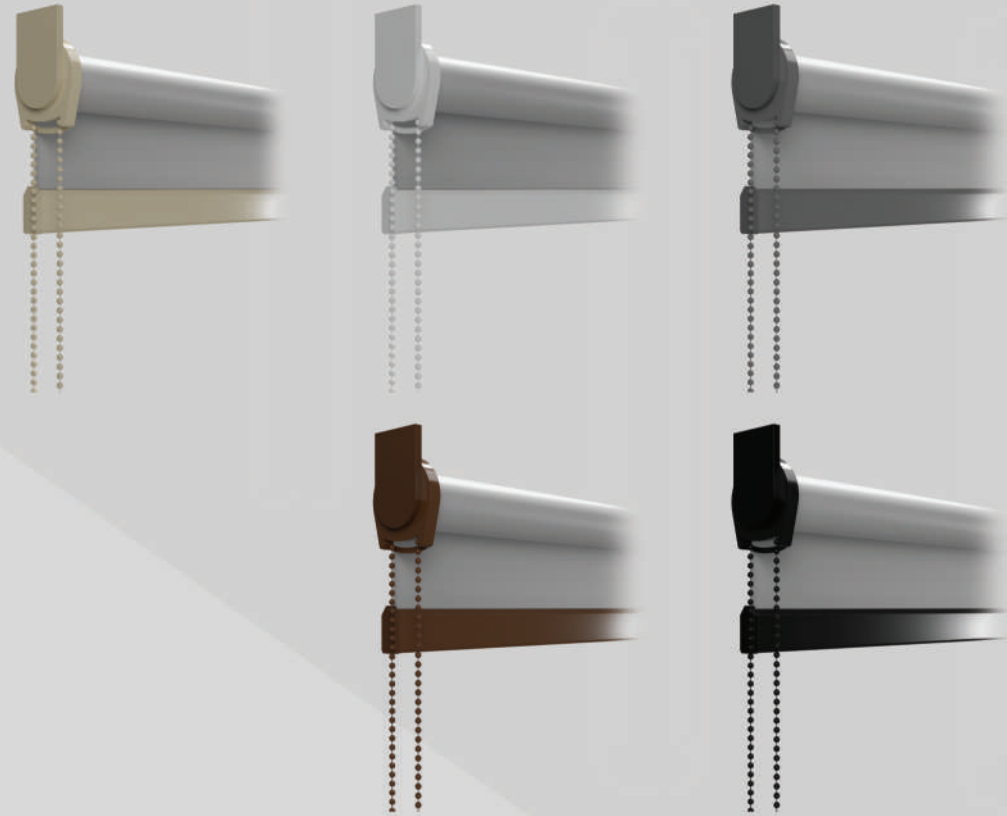
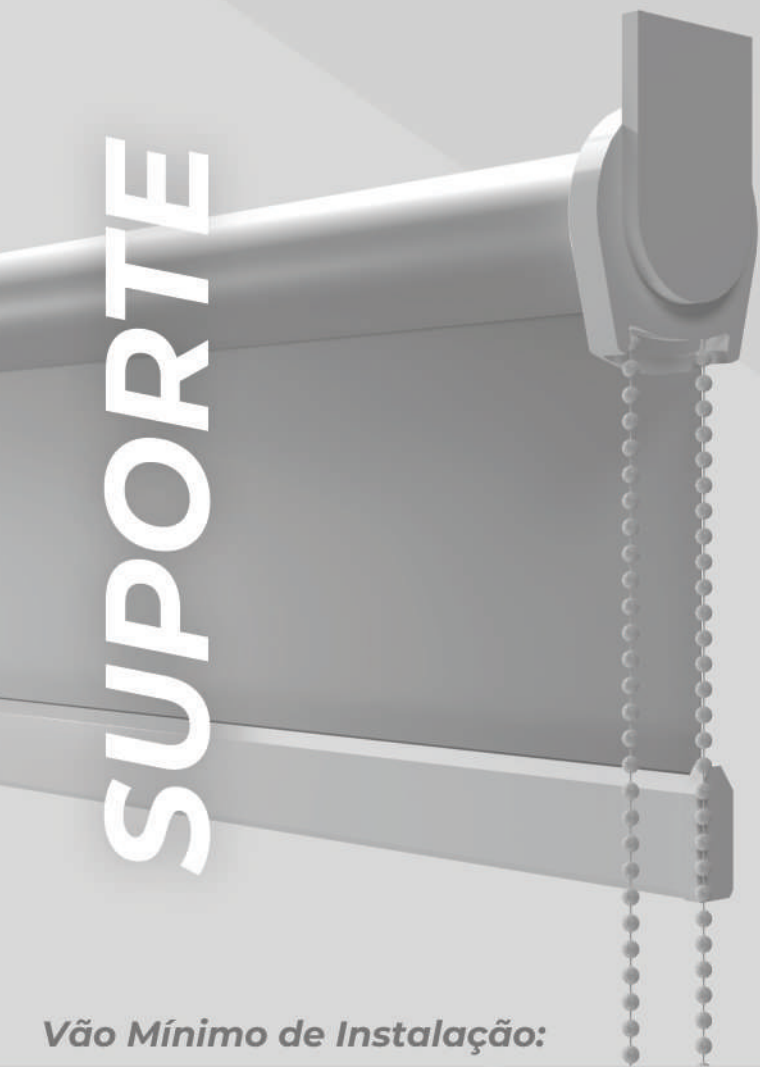

Vão Mínimo de Instalação:

MANUAL				MOTORIZADA			
Tubo	Vão Mín.		Acréscimo Altura do Tecido	Tubo	Vão Mín.		Acréscimo Altura do Tecido
32	42mm	+	10mm/M	38	42mm	+	9mm/M
38	42mm	+	9mm/M	45	47mm	+	8mm/M
45	47mm	+	8mm/M	55	82mm	+	6mm/M (A partir de 4,5m de altura)
55	68mm	+	6mm/M	70	92mm	+	5mm/M (A partir de 4,5m de altura)
				80	92mm	+	4mm/M

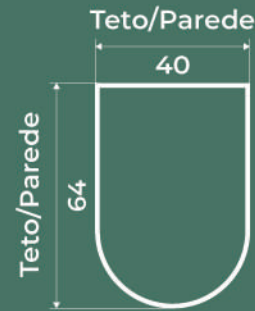

Possui fixação direta pelas laterais da cortina.

É fornecida sem custo adicional e está disponível com opção de pintura monocromática para um acabamento personalizado.

Bege, branco, cinza, marrom e preto: 32, 38, 45mm
Branco e preto: 55, 70, 80mm





NIVELADOR

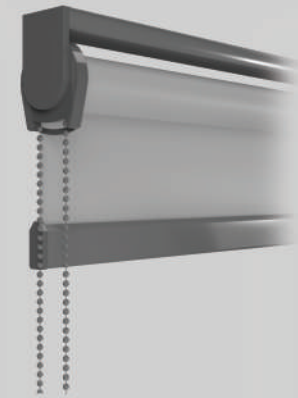
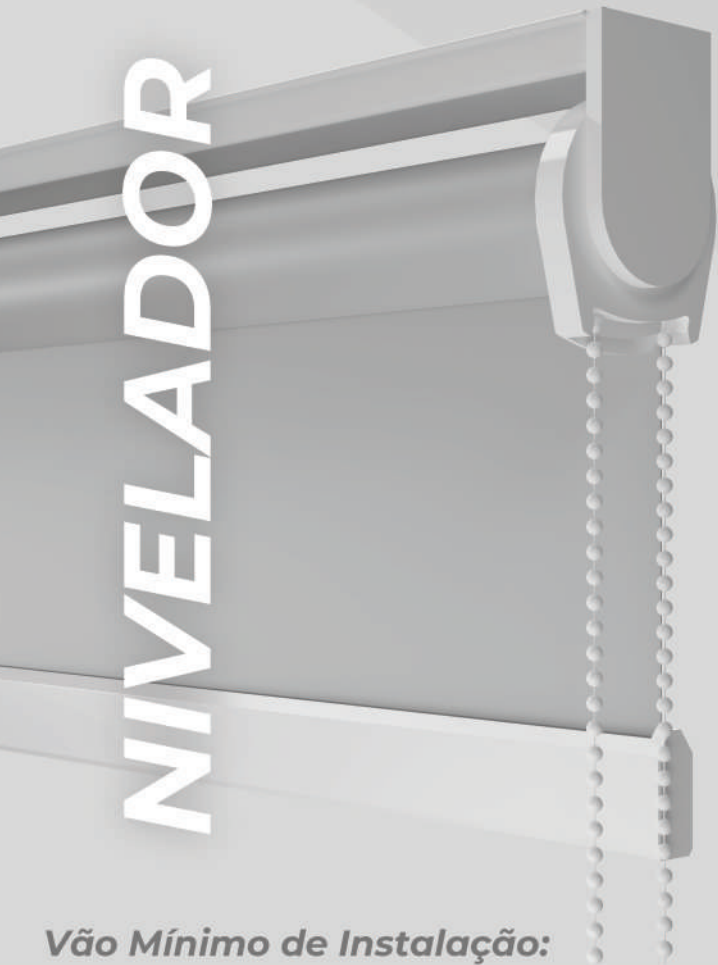

Vão Mínimo de Instalação:

MANUAL			MOTORIZADA		
Tubo	Vão Mín.	Acréscimo Altura do Tecido	Tubo	Vão Mín.	Acréscimo Altura do Tecido
32	55mm		38	55mm	
38	55mm	+ 9mm/M (A partir de 2m de altura)	45	55mm	+ 8mm/M
45	55mm	+ 8mm/M	55	81mm	+ 6mm/M (A partir de 4,5m de altura)
55	80mm	+ 6mm/M (A partir de 4m de altura)	70	81mm	+ 5mm/M
			80	81mm	+ 4mm/M

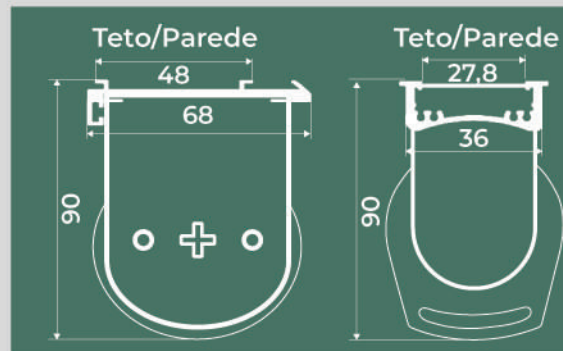

Solução prática para a instalação de cortinas.
Assegura um alinhamento perfeito e distribuição de peso. Opção de pintura monocromática.

Cores:
Bege, branco, cinza, marrom e preto: 32, 38, 45mm
Branco e preto: 55, 70, 80mm



BANDÔ 1720

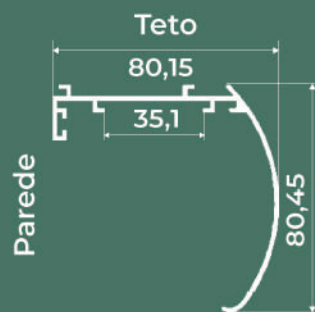
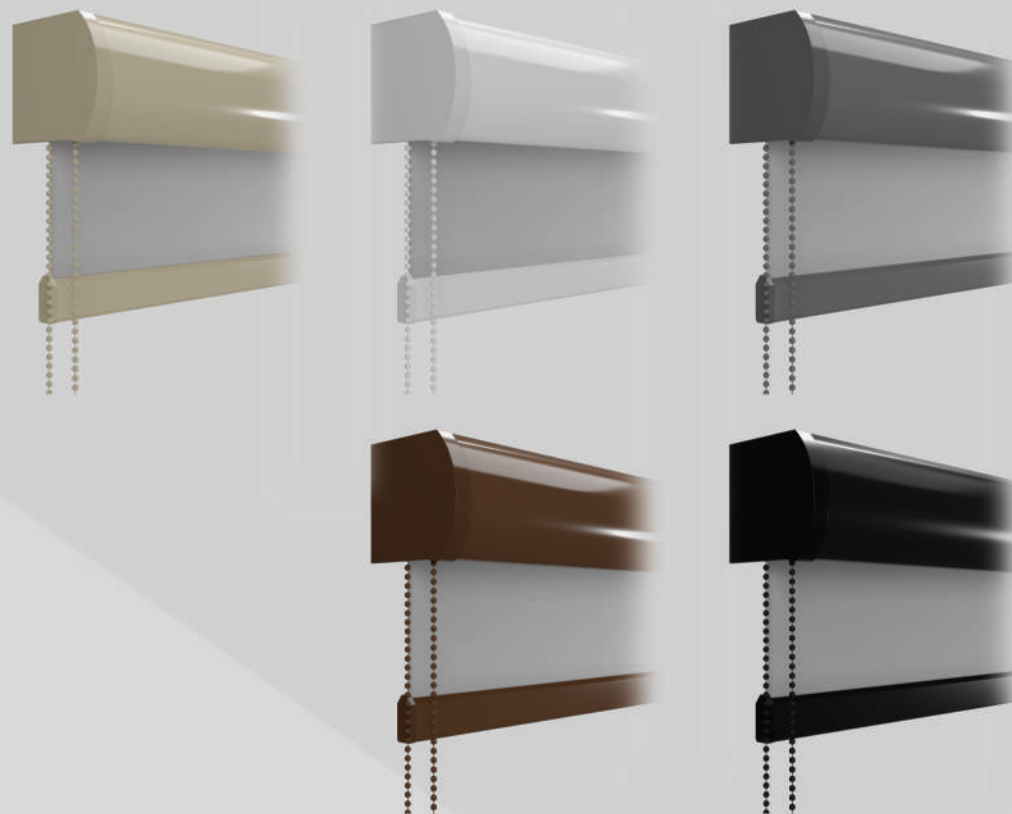
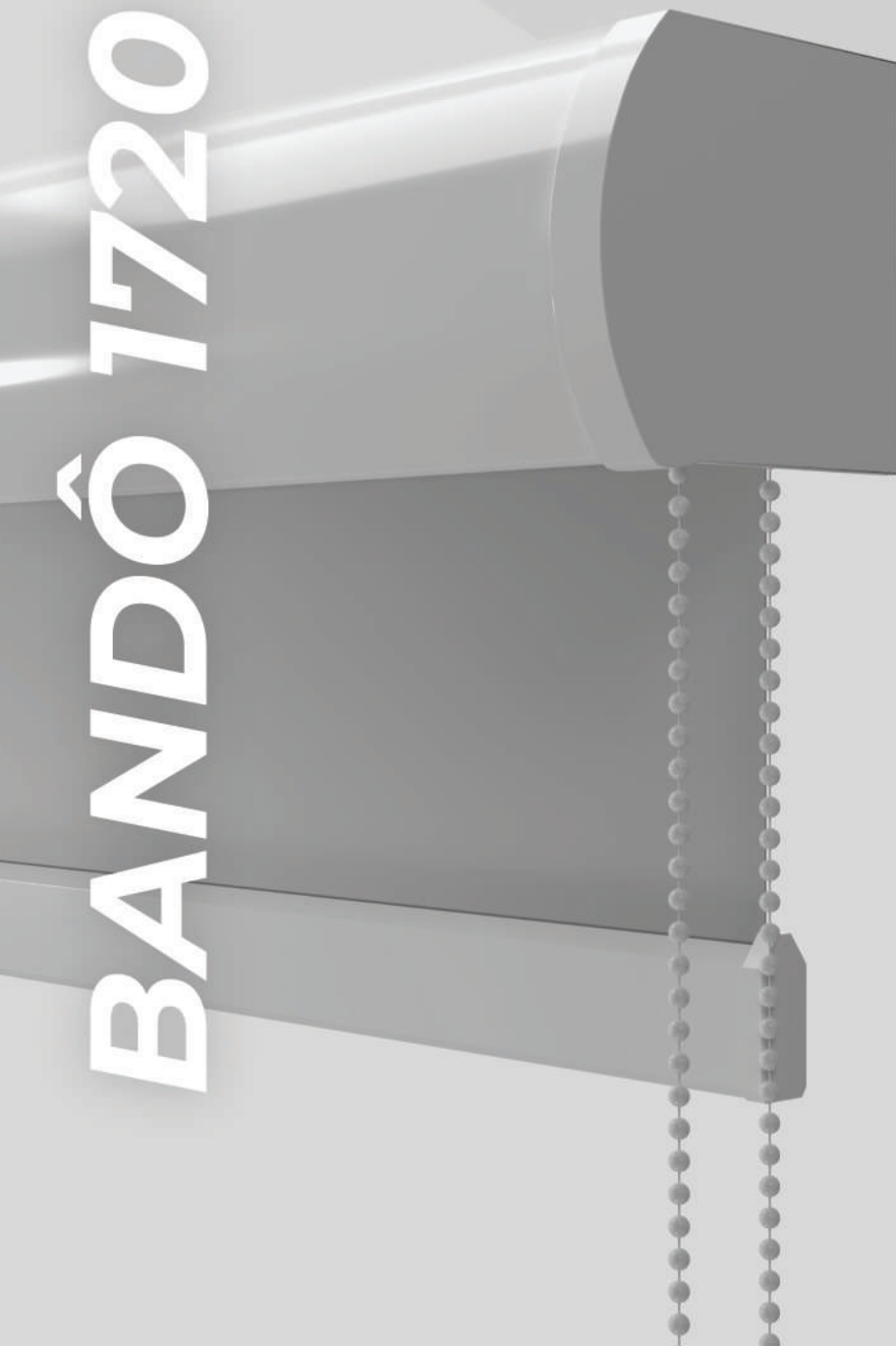

Modelo mais utilizado.

Possui uma abertura na parte de trás, sendo uma opção econômica e padrão para pintura monocromática.

Cores: Bege, branco, cinza, marrom e preto
Vão Mín. para instalação: 90mm





BANDÔ NEW BOX

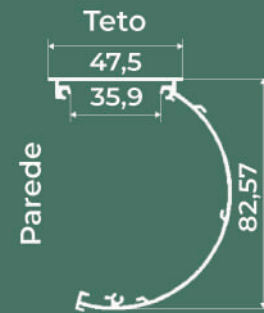
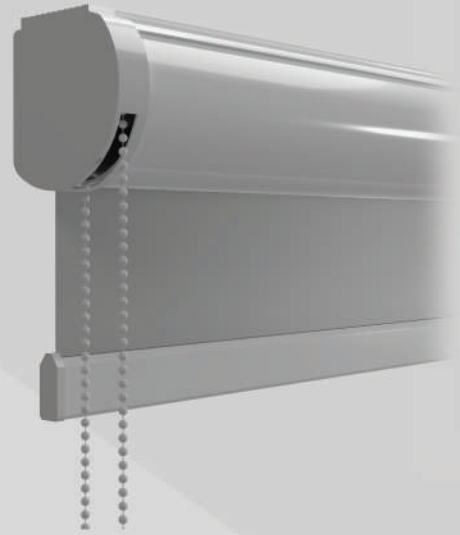

Proporciona redução na entrada da luz, cobrindo totalmente a cortina quando recolhida.

Cores: Branco e preto
Vão Mín. para instalação: 85mm





BANDÔ NEW BOX PREMIUM

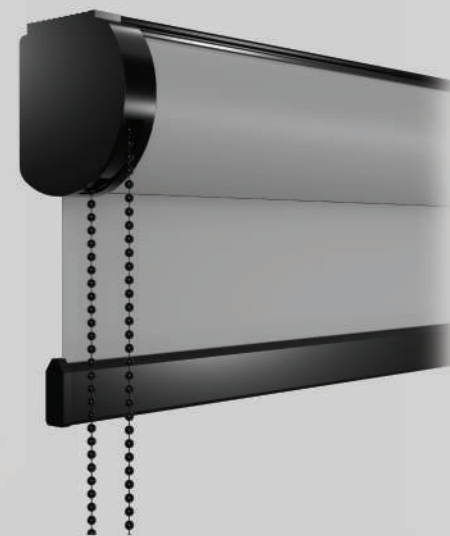
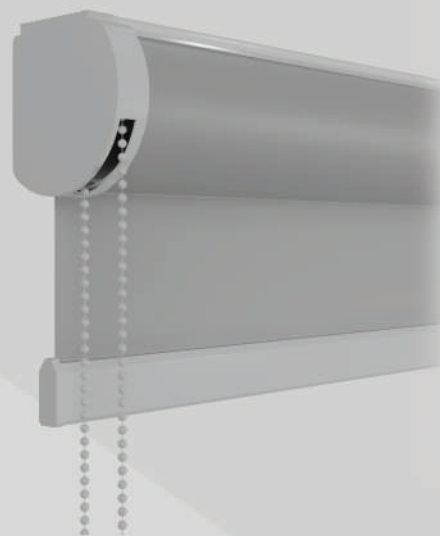
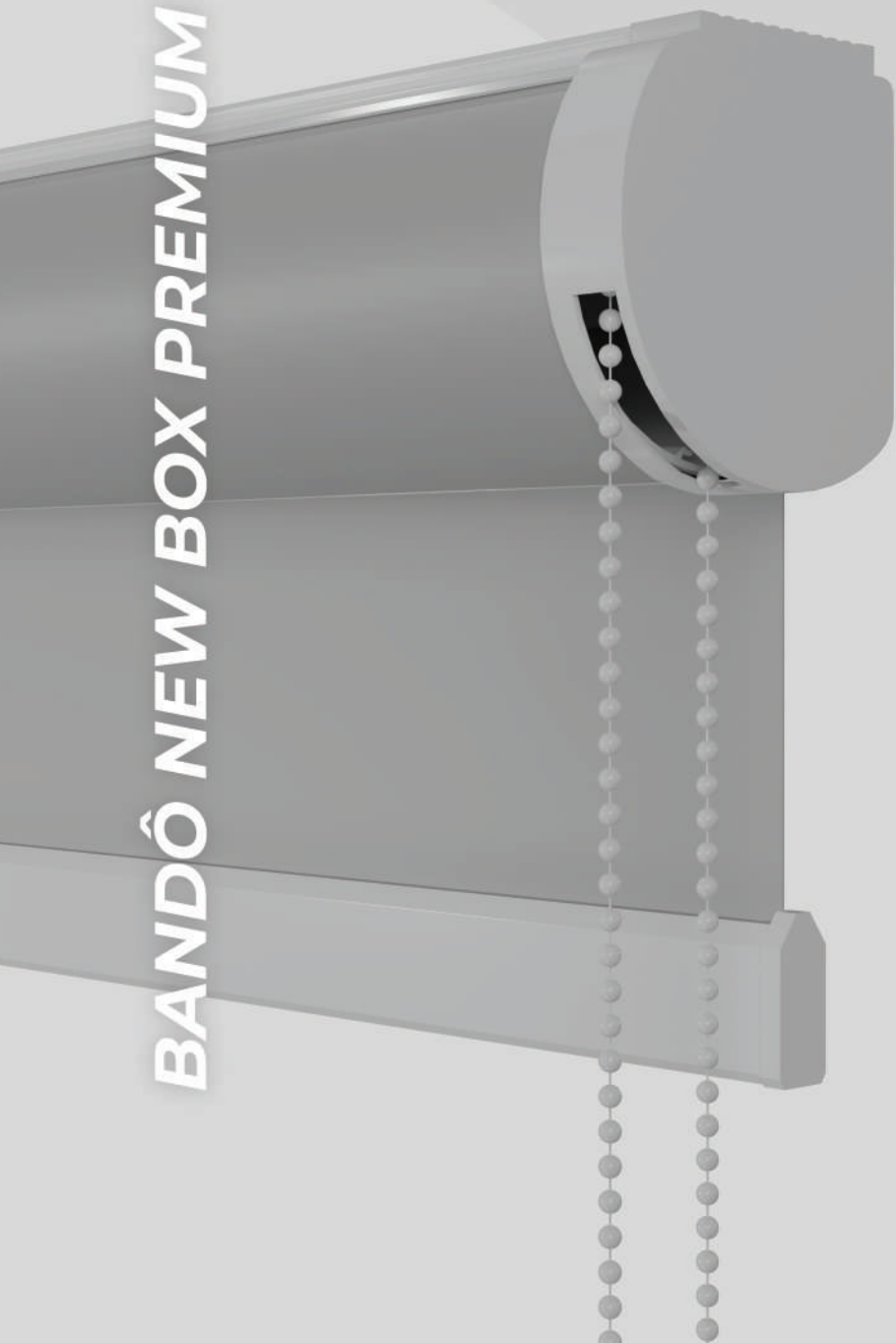

Proporciona redução na entrada da luz,
Apresenta as mesmas características que o New Box, porém é revestido com o mesmo tecido que compõe a cortina.

Cores: Branco e preto
Vão Mín. para instalação: 85mm

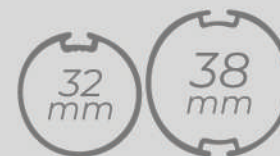



BOX REDONDO 70

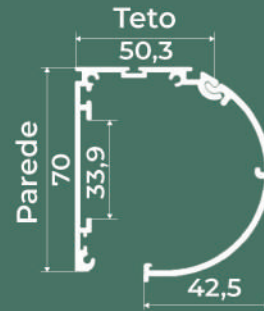
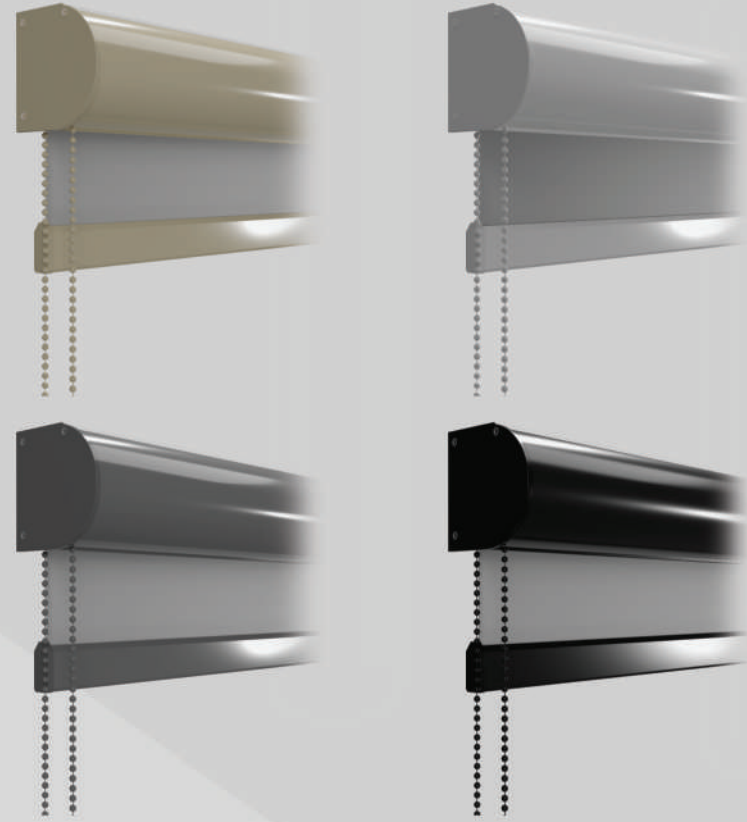
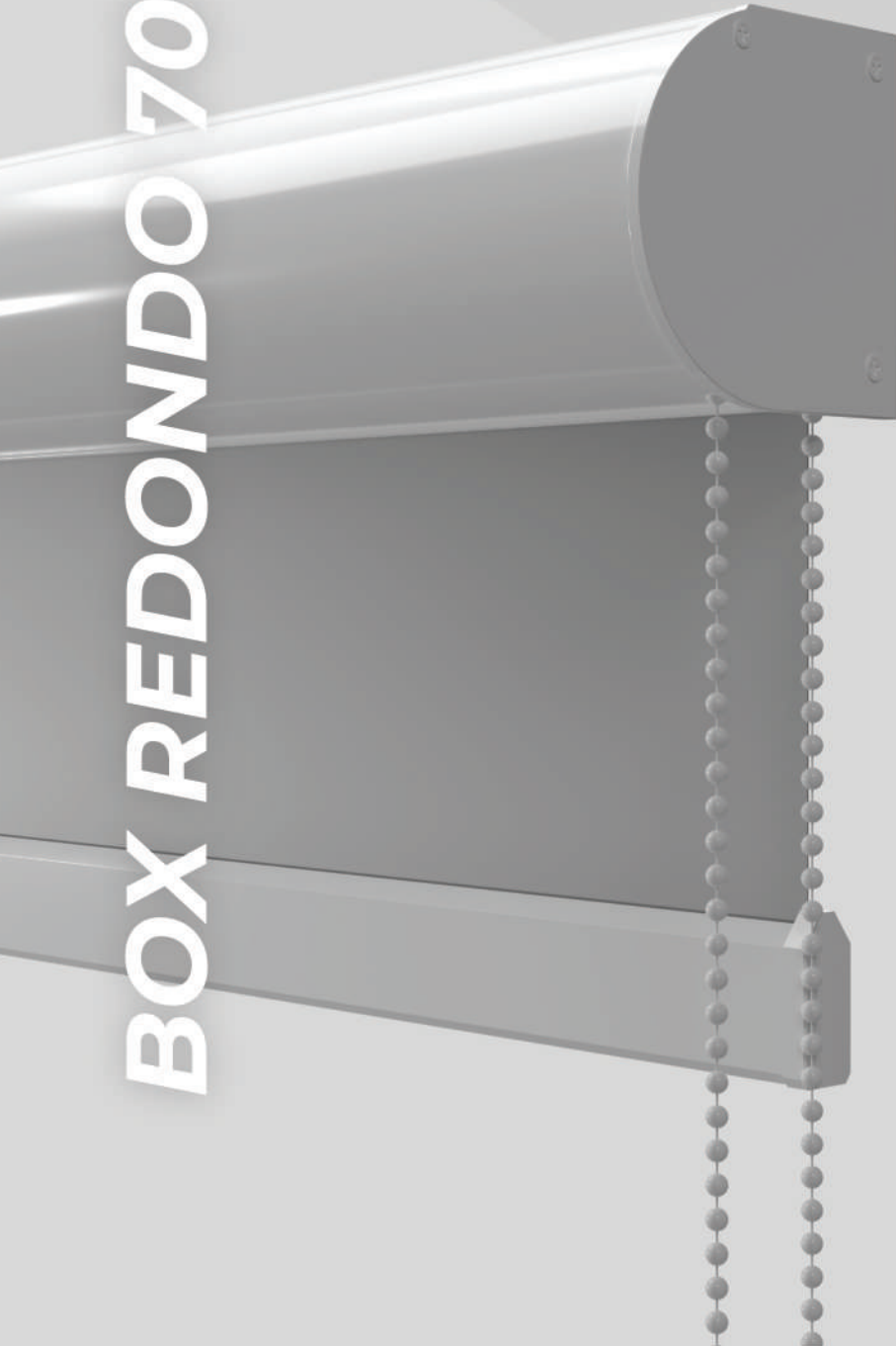

**Perfeito para ser usado
com as guias laterais.**
Com o fechamento na parte de
trás, proporciona vedação
completa da entrada de luz.
Pintura monocromática disponível.

Cores: Bege, branco, cinza e preto
Vão Mín. para instalação: 80mm

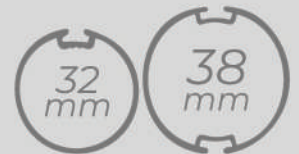



BOX REDONDO 90

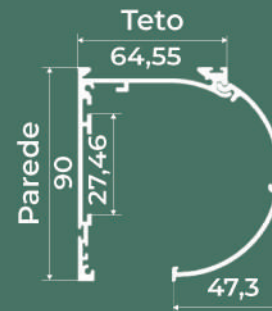
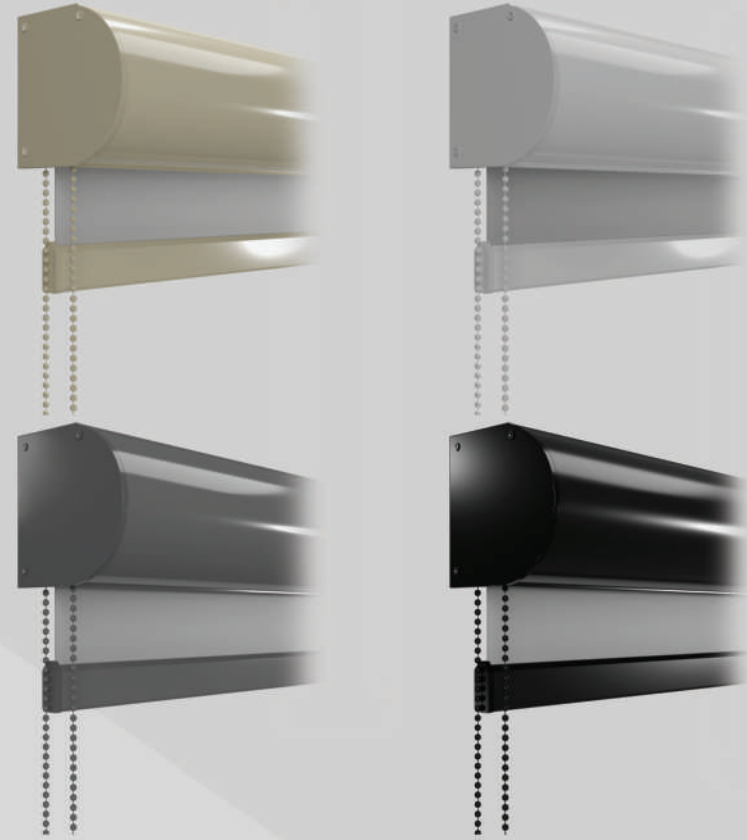
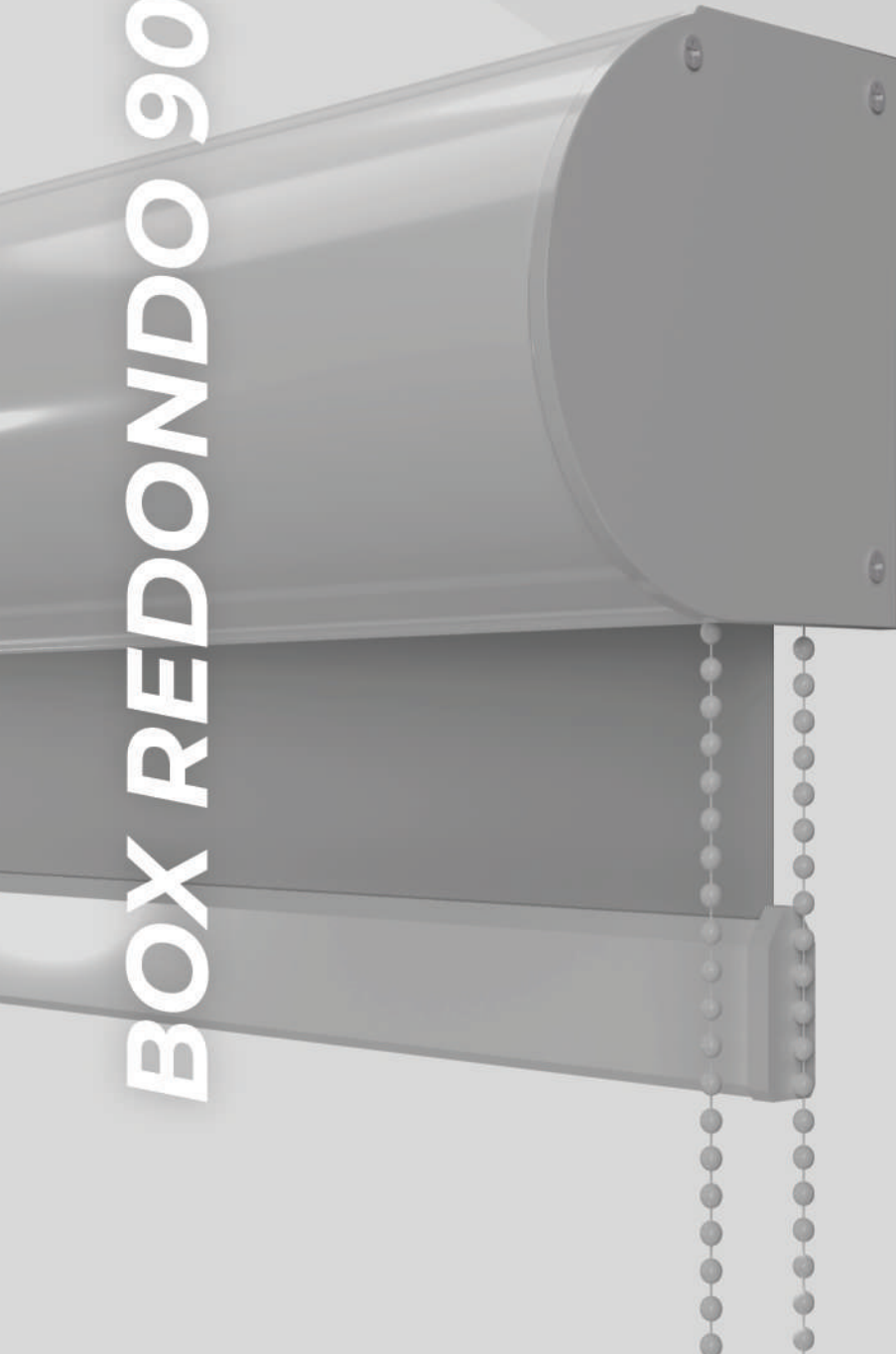

Perfeito para ser usado com as guias laterais.
Mantém as mesmas especificações do Box Redondo 70, porém é projetado para atender tubos de diâmetros maiores.

Cores: Bege, branco, cinza e preto
Vão Mín. para instalação: 90mm



BANDÔ PRIME 80



Lançamento:

Modelo premium da Persol, com acabamento microtexturizado e comando exclusivo em corda ou corrente, proporcionando movimento mais leve e fluido, valorizando ainda mais o resultado final do projeto.

Cores: Bege, branco, cinza e preto
Vão Mín. para instalação: 95mm

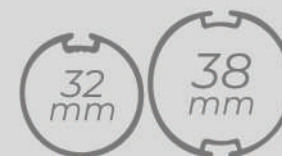

BANDÔ PRIME 100



Lançamento:

Mantém as mesmas especificações do Bandô Prime 80, porém foi projetado para atender tubos de diâmetros maiores, garantindo a mesma performance e segurança mesmo em estruturas mais robustas.

Cores: Bege, branco, cinza e preto
Vão Mín. para instalação: 120mm





BOX QUADRADO 90

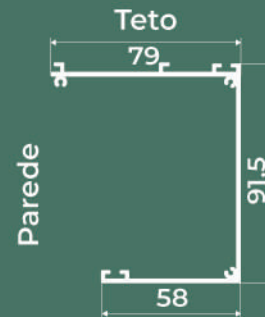
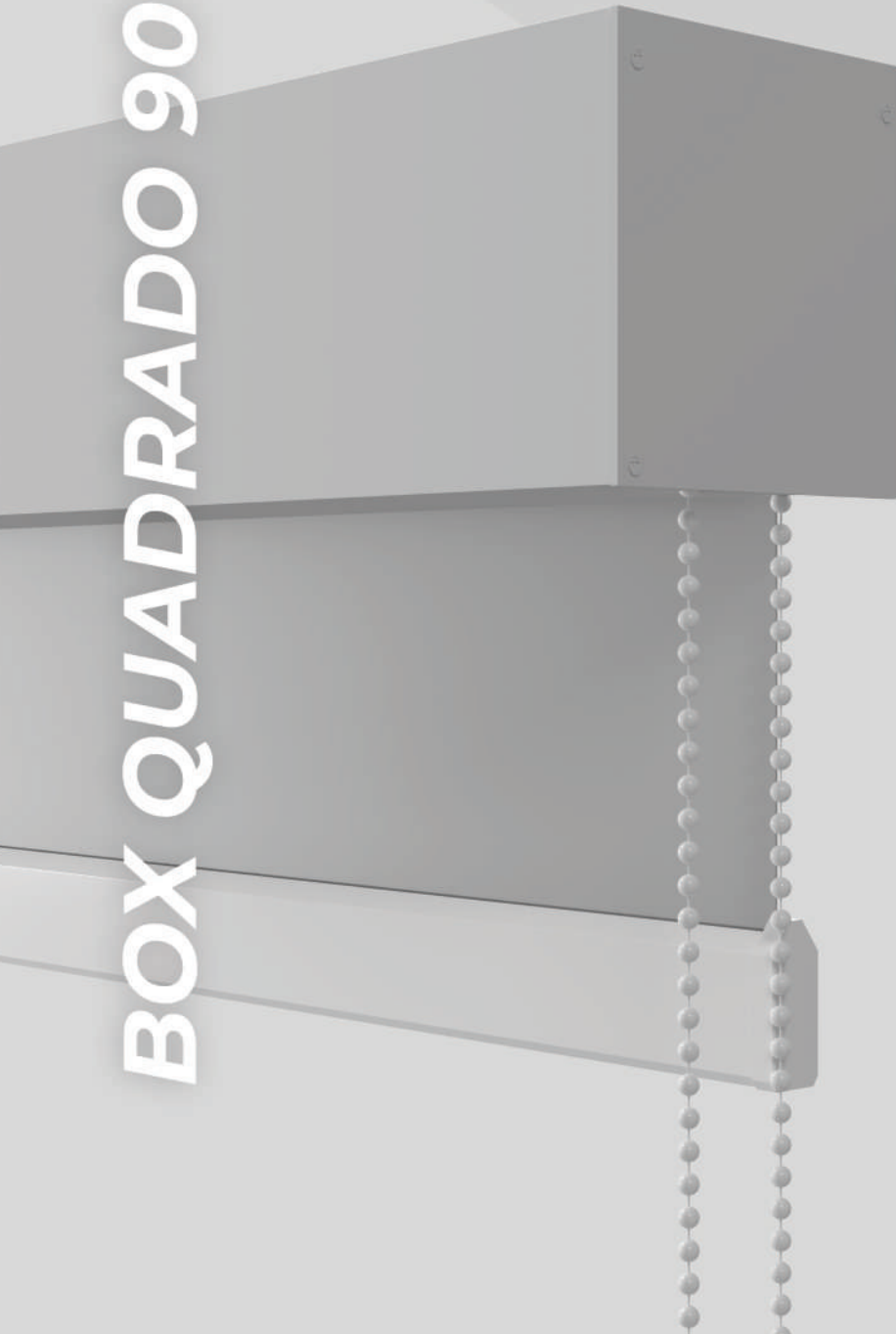

Possui design com linhas retas e sem arredondamento frontal.

Seu formato diferenciado cobre completamente o rolo da cortina e proporciona eficaz redução na entrada de luz.

Cor: Branco
Vão Mín. para instalação: 95mm





BOX QUADRADO 100

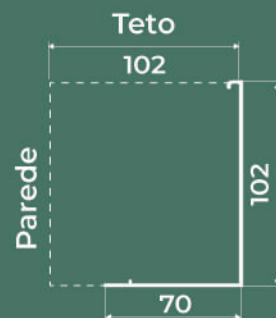
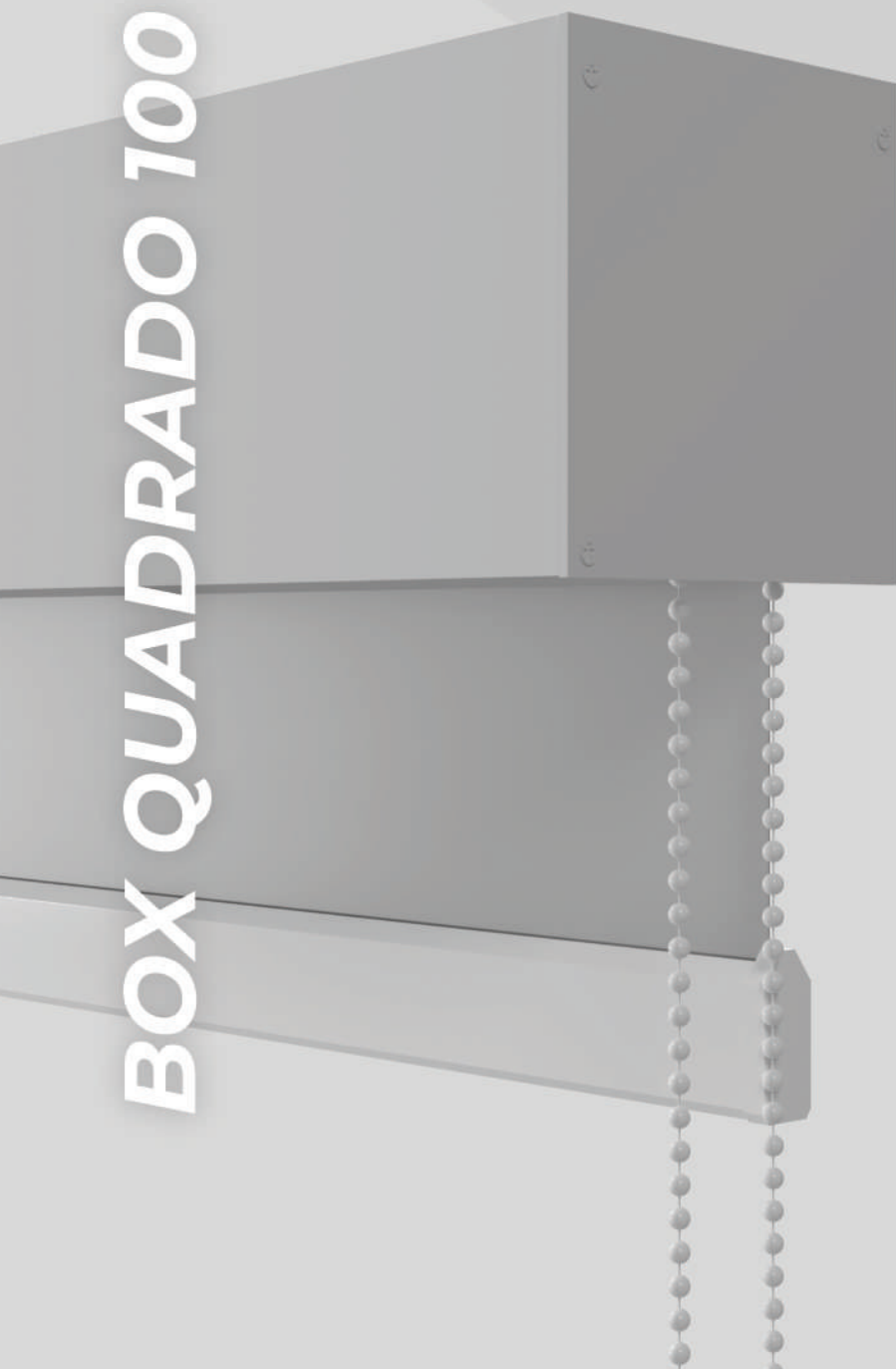

Possui design com linhas retas e sem arredondamento frontal.
Contém as mesmas especificações do Box Quadrado 90, porém foi projetado para atender diâmetros maiores de tubos.

Cor: Branco
Vão Mín. para instalação: 110mm





BOX 120 ULTRA



Ideal para grandes dimensões e projetos exclusivos.
Este modelo possui uma aba na parte inferior que aprimora o acabamento.

Cores: Branco e preto
Vão Mín. para instalação: 145mm

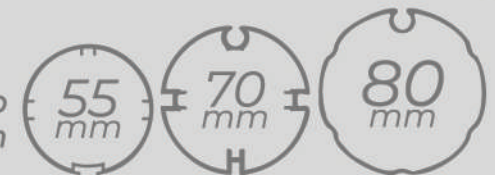



SEMI BOX 120 ULTRA

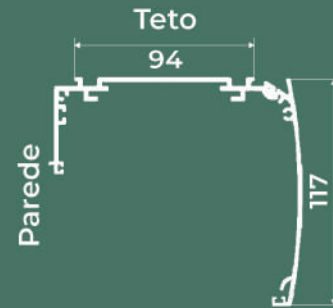
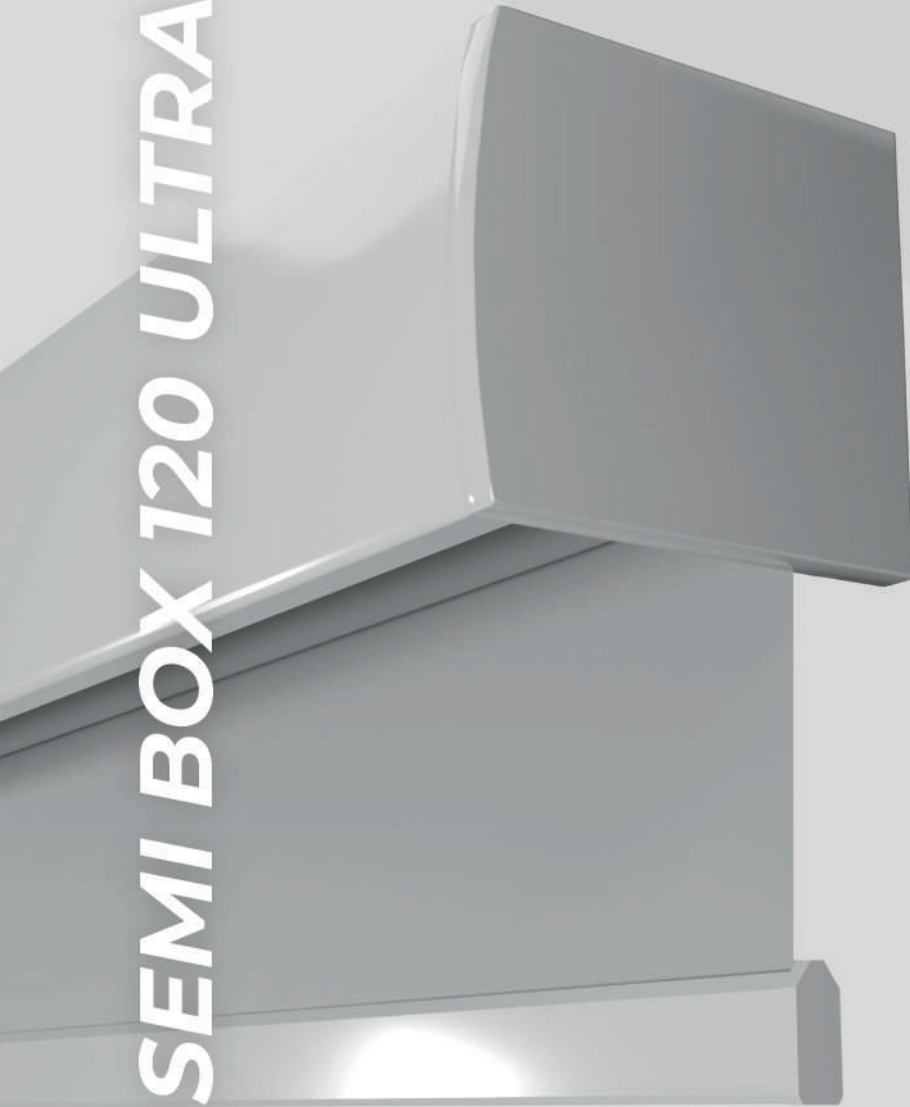

Ideal para grandes dimensões e projetos exclusivos.

Semelhante ao Box 120 Ultra, porém com abertura na parte inferior, possibilitando o rolamento do tecido

Cores: Branco e preto
Vão Mín. para instalação: 145mm

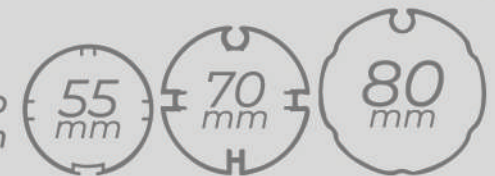



BANDÔ MAXI

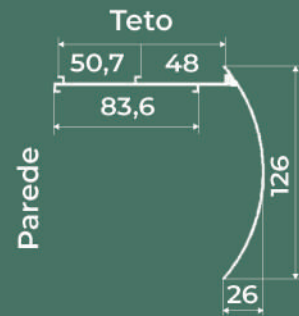
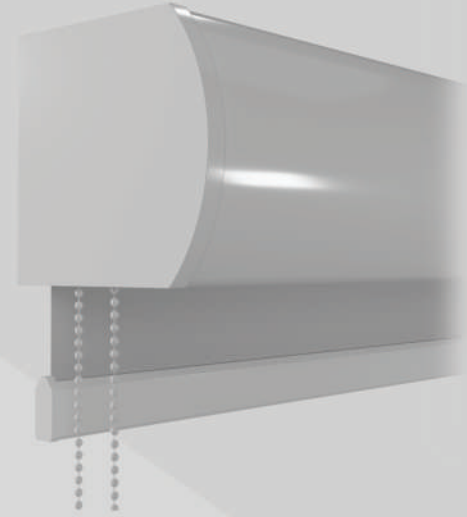
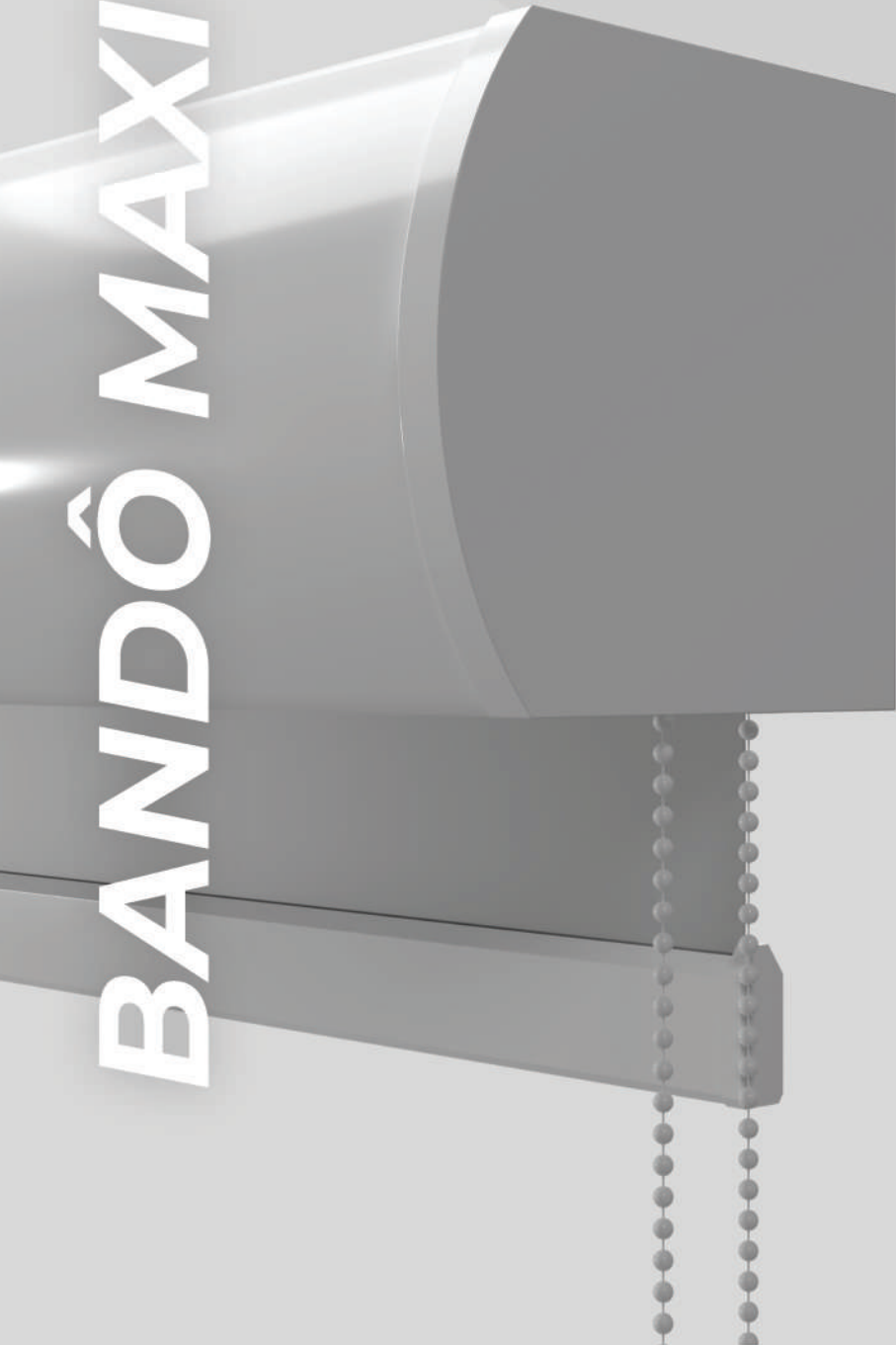

Projetado para tubos com diâmetros maiores.
Modelo semelhante ao Bandô 1720, porém desenvolvido para atender projetos de maior escala.

Cores: Branco e preto
Vão Mín. para instalação: 145mm

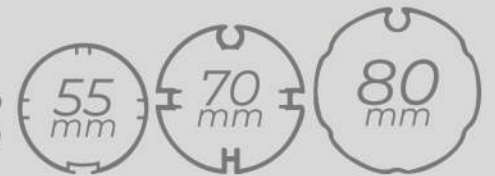



ACIONAMENTO MOLA

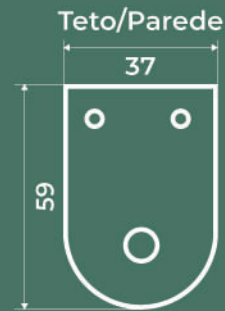

Acionamento retrátil.
Equipado com uma mola interna que recolhe automaticamente o tecido, sem precisar de cordas ou correntes.

Cor: Branco
Vão Mín. para instalação: 37mm + 10mm/M





SUPORTE DUPLO DIA E NOITE

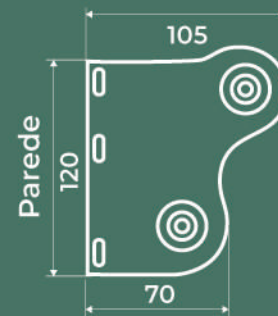
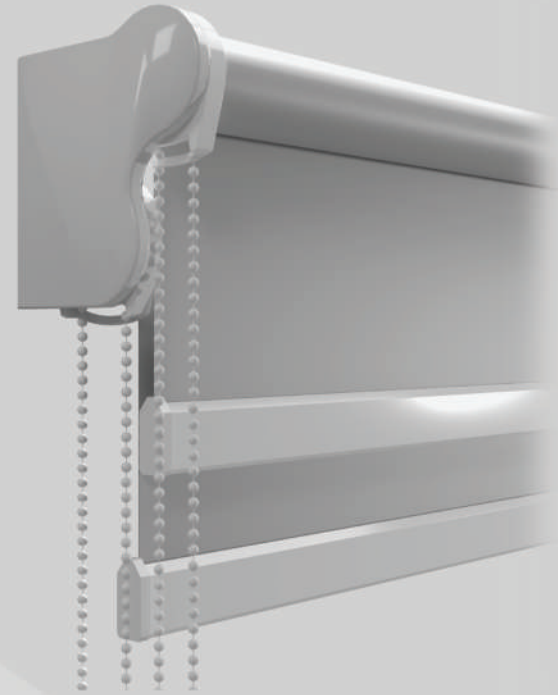
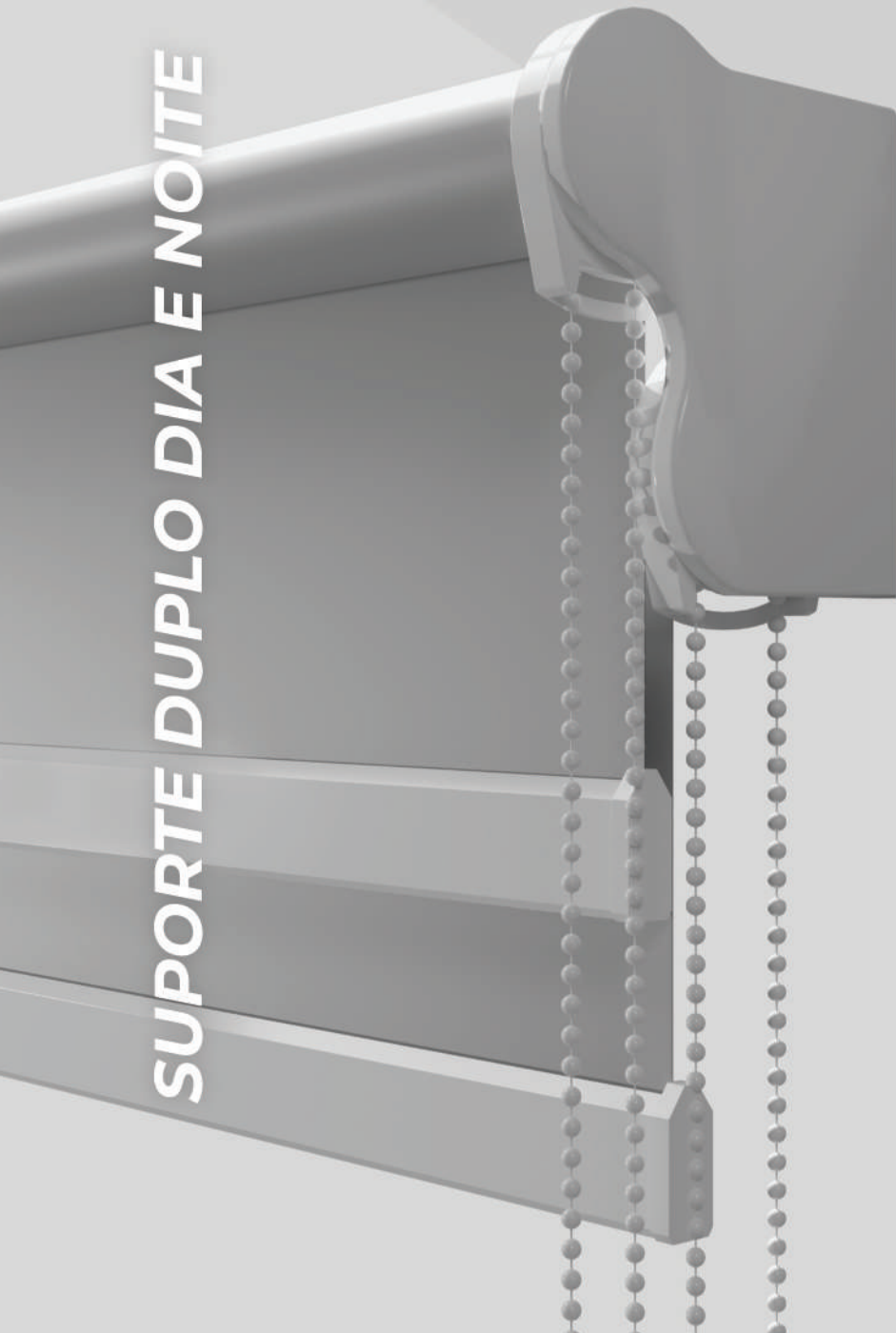

Projetado para a instalar duas cortinas com tecidos diferentes.
Possui acionamentos independentes para maior flexibilidade.

Cor: Branco
Vão Mín. para instalação: 140mm





TRILHO DESGLIZANTE

Vão Mínimo de Instalação:

MANUAL

Tubo	Vão Mín.	Acréscimo Altura do Tecido
32	55mm	
38	55mm	+ 9mm/M (A partir de 2m de altura)
45	55mm	+ 8mm/M
55	80mm	+ 6mm/M (A partir de 4m de altura)

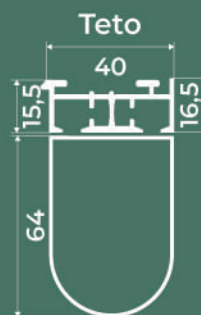

Possibilita o movimento lateral da Cortina Rolô.
Semelhante ao painel, o trilho deslizante permite a funcionalidade do recolhimento do tecido, sendo ideal para sacadas com espaço limitado.

Cor: Branco



GUIA LATERAL 60mm

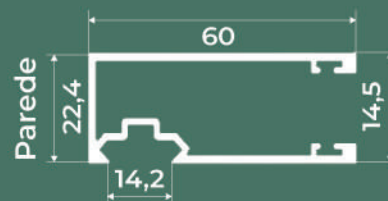
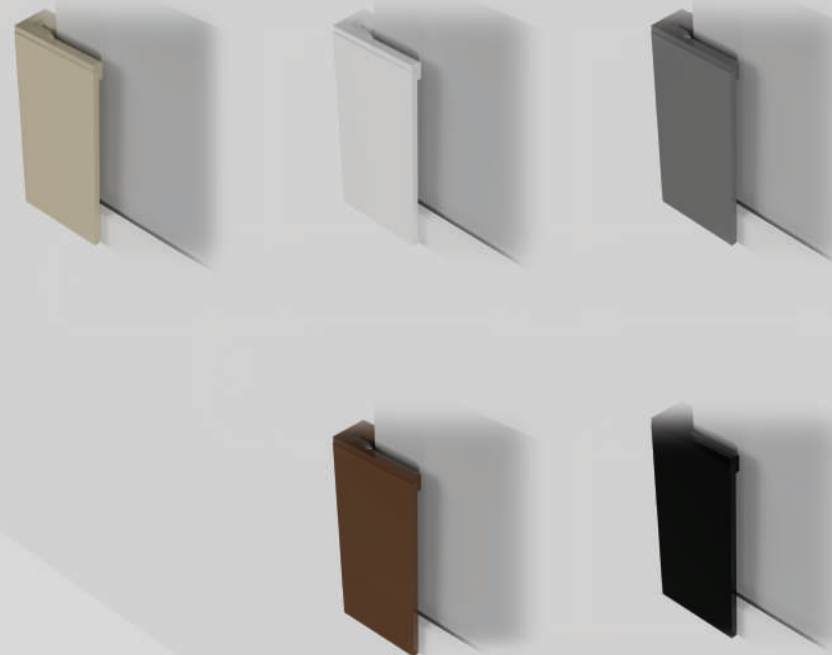

**Projetado para
minimizar as frestas.**

*Ideal para uso com box redondo
e tecido blackout, oferecendo
vedação completa e controle
total da iluminação.*

Cores: Bege, branco, cinza, marrom e preto
Vão Mín. para instalação: 25mm



GUIA LATERAL 80mm

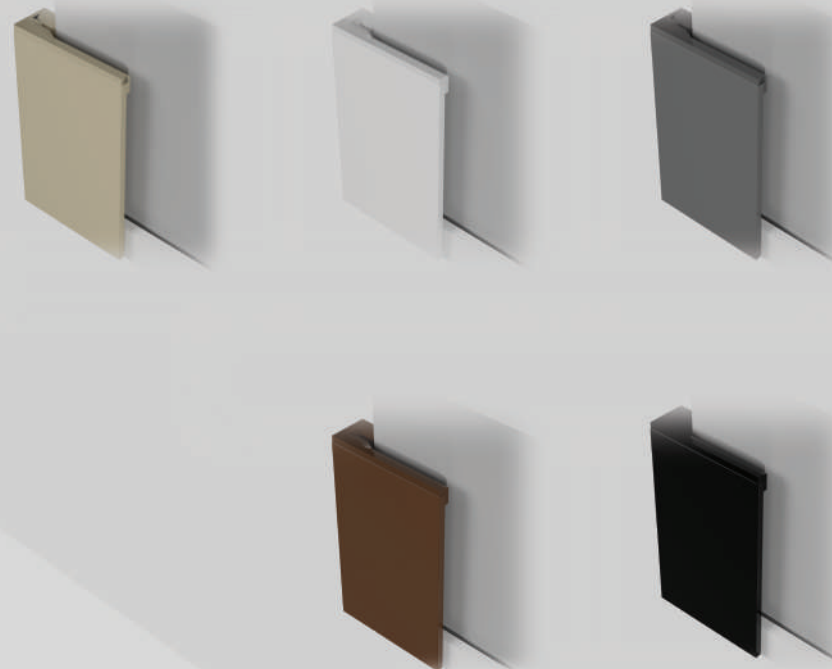

Projetado para minimizar as frestas.

Possui as mesmas especificações que a guia lateral 60mm, porém foi projetada para cortinas de maiores dimensões.

Cores: Bege, branco, cinza, marrom e preto
Vão Mín. para instalação: 25mm





BASE SLIM

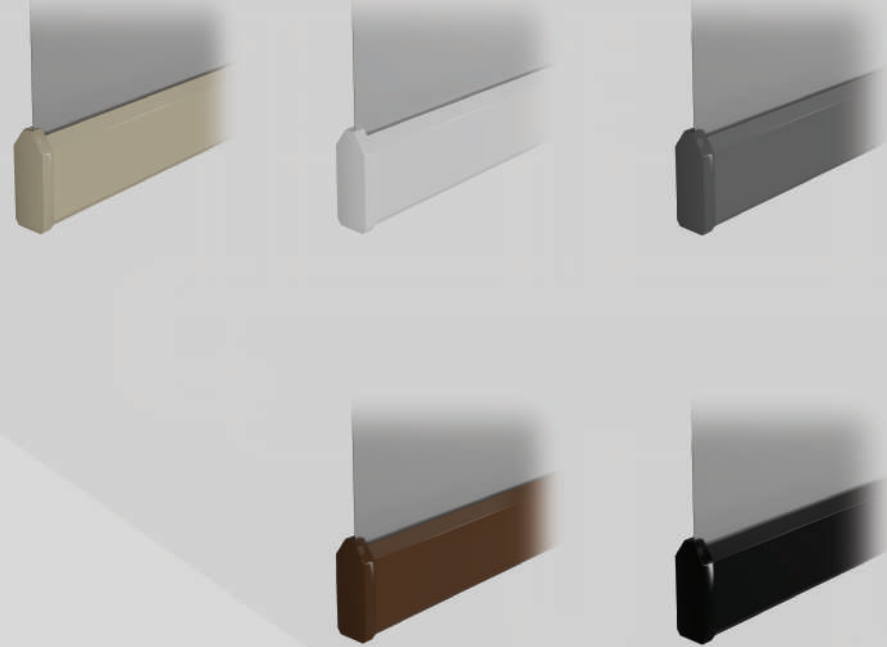

Acabamento inferior exposto no produto.
Proporciona um visual minimalista e está disponível com opção de pintura monocromática.

Cor: Bege, branco, cinza, marrom e preto

32 ao
80mm

BASE REVESTIDA COM SOLDA

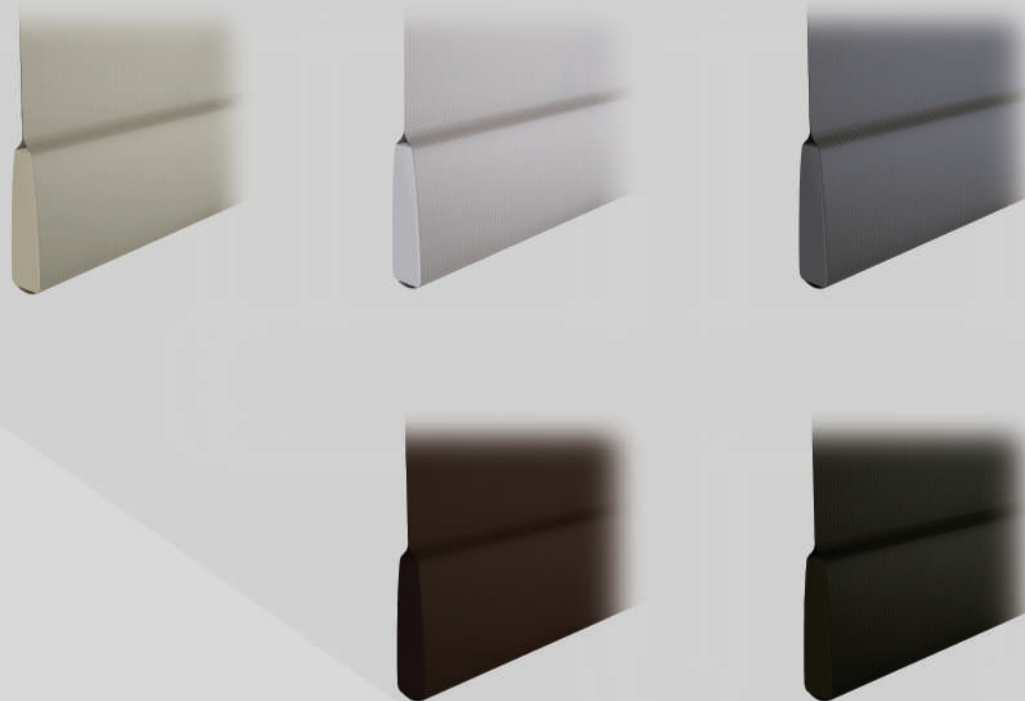

Base revestida pelo tecido da cortina.
Oculta totalmente o perfil, garantindo um acabamento uniforme. Padrão para as coleções Screen e Blackout Solflex.

Cores: Bege, branco, cinza, marrom e preto

32 ao
80mm



BASE OVAL REVESTIDA

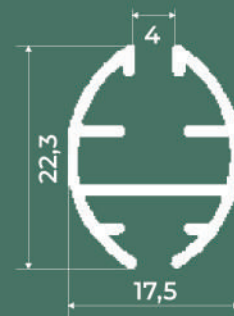
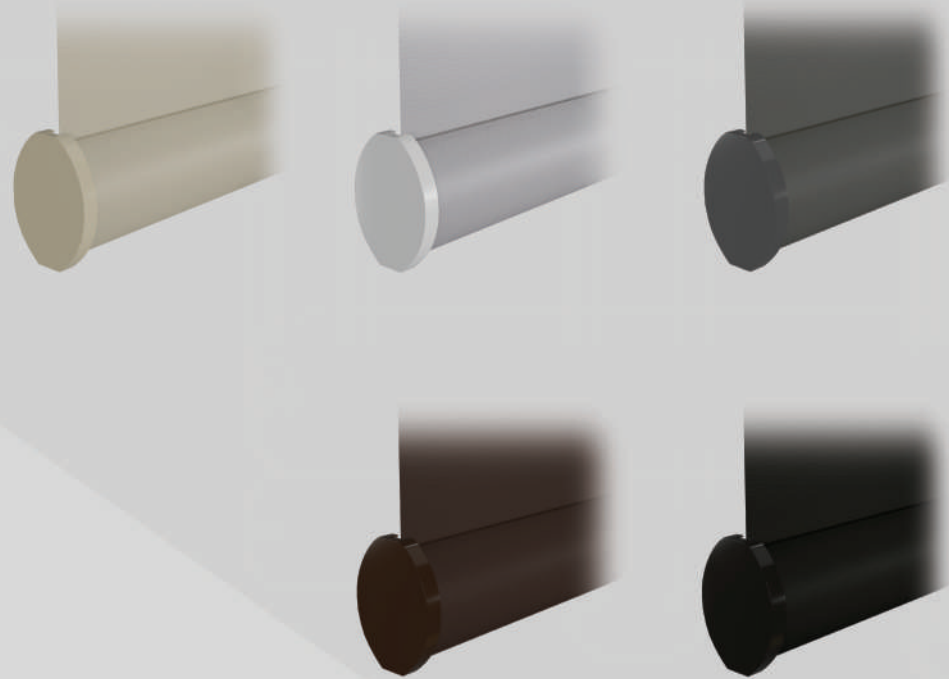
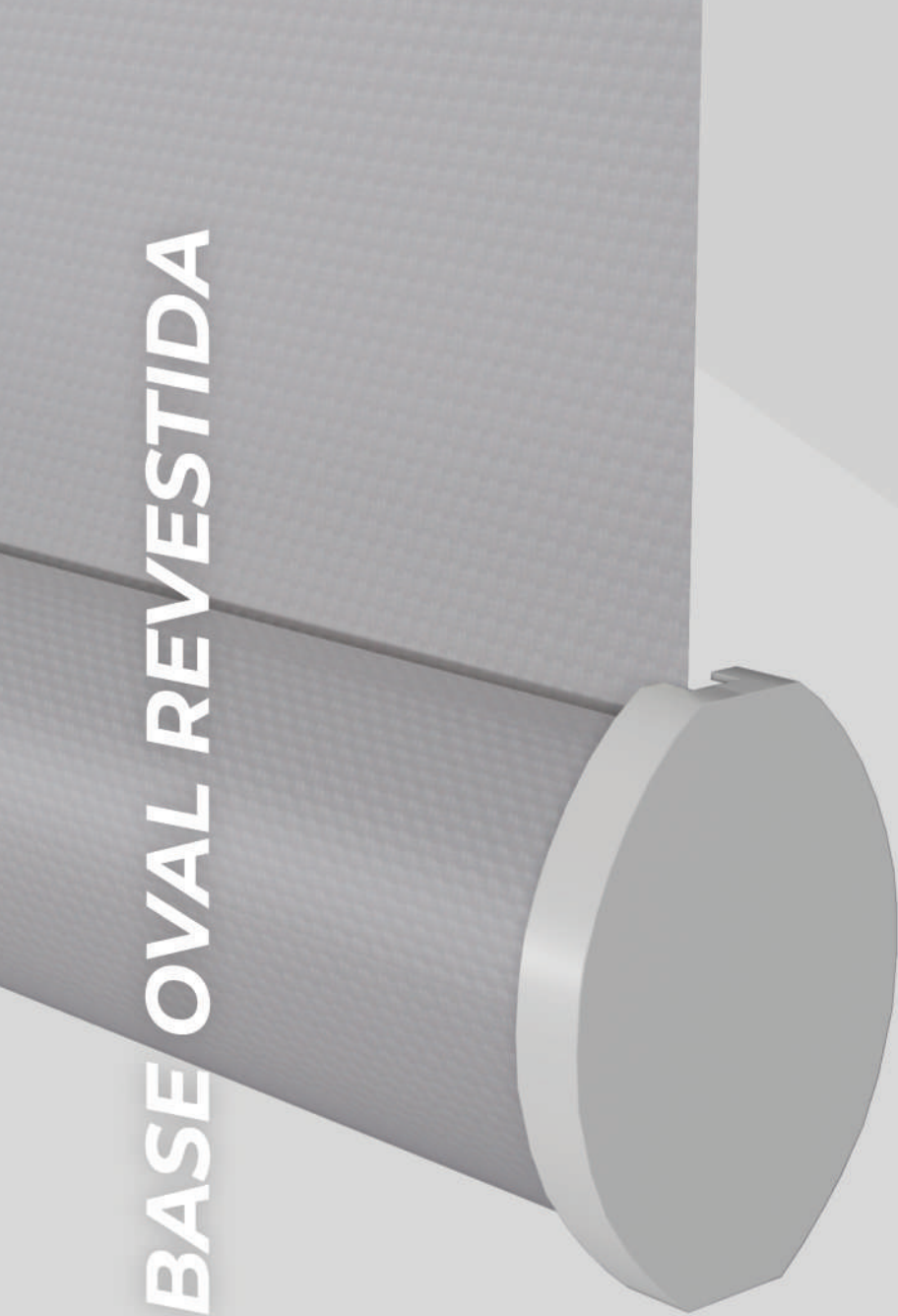

Perfil de alumínio inferior com design oval.
Quando optado por esse modelo, o perfil segue com sua parte frontal revestida pela coleção de tecido usada no produto.

Cores: Bege, branco, cinza, marrom e preto





| Escolha **sentir**

www.persolpersianas.com.br